

TOOLMAKERS' LATHES

SV 65 + SV 70

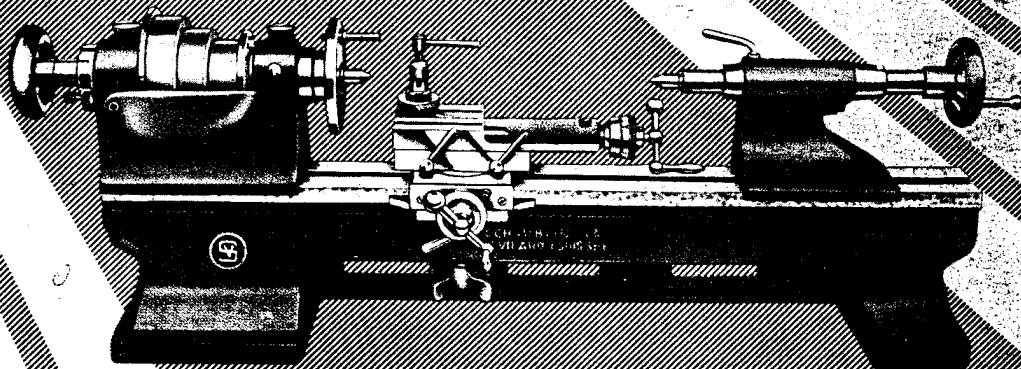

**MACHINE-TOOL MANUFACTURERS
SCHAUBLIN LTD. BÉVILARD SWITZERLAND**

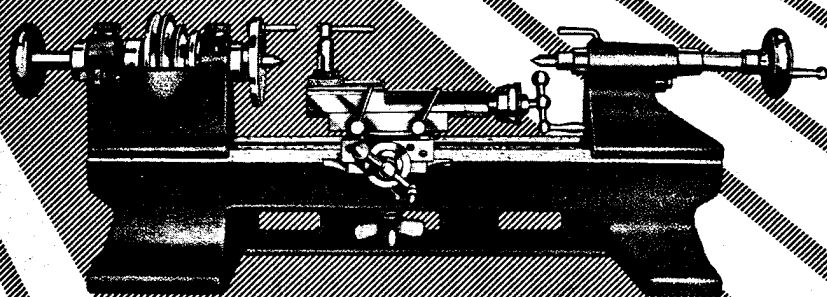

MAIN FACTORY AT BÉVILARD

Machines

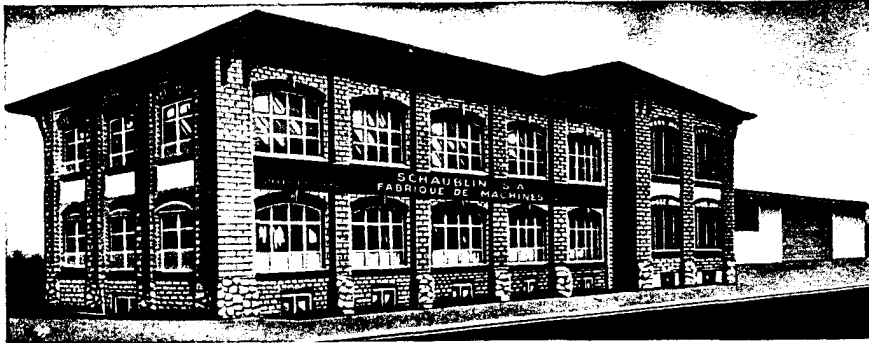

MALLERAY BRANCH

Experimental Department and School

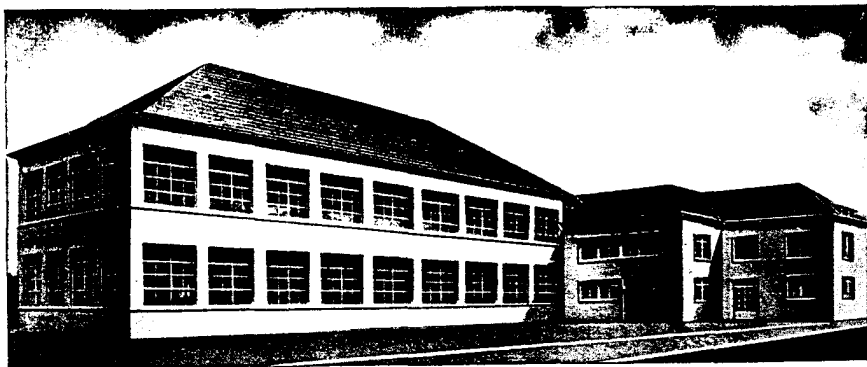

DELÉMONT BRANCH

Manufacture of Collets and Similar Accessories

ACCURACY - INTERCHANGEABILITY



GENERAL CONDITIONS OF SALE

PRICES

Unless otherwise stated, all prices quoted are strictly nett, exclusive of packing, ex Malleray-Bévilard station.

PACKING

Packing is charged extra, the cost being approximately 1 % to 2 % of the invoice amount. If packing is returned in good condition, carriage paid, to Malleray-Bévilard station, credit is given for $\frac{3}{4}$ of the amount charged.

TERMS OF PAYMENT

Only the terms of payment stipulated in our quotations are valid. Consignments can be held over for customers, if so desired, provided that sufficient storage space is available. In no case, however, will such warehousing justify any delay in payment. Interest on delayed payment will be calculated at the rate of 6 % per annum.

DELIVERY

Delivery dates are given as exactly as possible, and every effort is made to adhere to them. No responsibility can be accepted for circumstances outside our control, such as acts of God affecting manufacture or transport, delivery of unacceptable goods from suppliers, strikes or lock-outs at our works or at the works of our suppliers, or failure on the part of the customer to comply with the terms of payment agreed upon.

No penalty can be accepted for delay, and no orders can be cancelled on that account.

TRANSPORT

The greatest possible care is exercised in packing, and we decline all responsibility for damage incurred in transit. Shipment is effected at the consignee's risk, even when the cost of transport is borne by us. Therefore, we advise our customers, before they accept delivery, to check the goods with the forwarding agents for damage, breakage, loss, delay in transport, etc., so that they may, if necessary, claim compensation. Should this formality be omitted, the consignee will be entirely responsible for any loss sustained.

DOCUMENTS

It is forbidden, without our consent, to reproduce drawings, prints, floor-space diagrams, printed matter, or quotations, or to place these at the disposal of third parties or competitors.

We reserve the right to alter the design of our products at any time, without notice. Neither the illustrations in this catalogue nor the weights indicated are binding.



SV MACHINES

The reputation enjoyed by SV Machines is the outcome of research and experience spread over a third of a century.

Full advantage is taken of the latest technical improvements and manufacturing processes, and this places SV Machines foremost in their category. The main characteristics of these machines are :

EXQUISITE WORKMANSHIP
COMPLETE INTERCHANGEABILITY OF ALL MACHINE PARTS
GREAT ACCURACY OF WORK
HIGH OUTPUT
ATTRACTIVE APPEARANCE

TOOLMAKERS' LATHES SV 65/70

These small lathes are especially intended for technicians engaged in the manufacture of watches and small instruments. They are used to advantage also in the manufacture of small precisiontools of all kinds and in experimental departments and laboratories

In addition to the standard equipment for ordinary turning work between centres, in collets or in chucks, the SV 65 and SV 70 lathes embody the various special attachments required by gauge makers.

The profile of the bed and the system of clamping used guarantee perfect centring of the various units fitted. A rib connecting the two legs, at the rear of the bed, prevents distortion and at the same time ensures great rigidity of the lathe as a whole.

The essential difference between the SV 65 and SV 70 lathes lies in the capacity of the headstocks :

The SV 65 headstock takes type W 10 collets of 6,2 mm capacity and is driven by a grooved pulley for round belt of 6 mm diameter.

The SV 70 headstock takes type W 12 collets of 8,2 mm capacity and is driven by a 3-step pulley for flat belt, width 18 mm.

For special work the headstock can be replaced at any time by one of the models of quill-holder headstocks with spindle for collet or with faceplate with tapped holes and slots for clamping dogs. In order to eliminate pull and vibration due to the belt, the drive of the quill-holder headstock is indirect. It is effected through a driver support carrying the drive pulley and mounted at the end of the bed.

The quills with faceplate are generally provided with a system of centring from the rear, known as " pump " centring. An attachment for centring from the front is mounted on the carriage in place of the tool. For particularly delicate centring work, use is made of the attachment for centring by microscope with illumination by electric bulbs and swivelling support, mounted directly on the lathe bed.

The drive of the SV 65 and SV 70 lathes can be effected by countershaft on bench, on bars or on the ceiling or by individual drive. The latter is mounted on the bench, at the rear of the lathe. It comprises a countershaft mounted on a swivelling support adjustable in height on a rigid column.

The drive motor, fixed on a base plate, has a power of $\frac{1}{3}$ hp at 1500 rpm.



TOOLMAKERS' LATHES

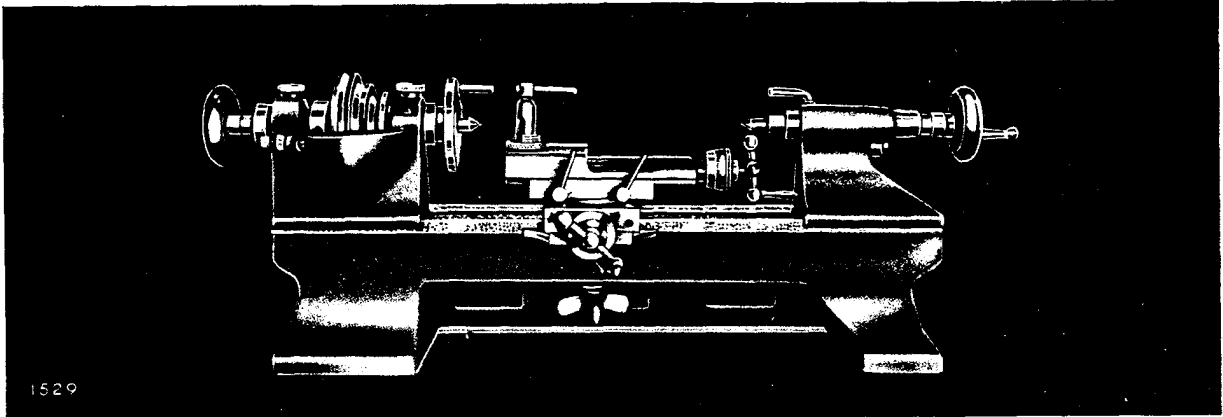

SV 65

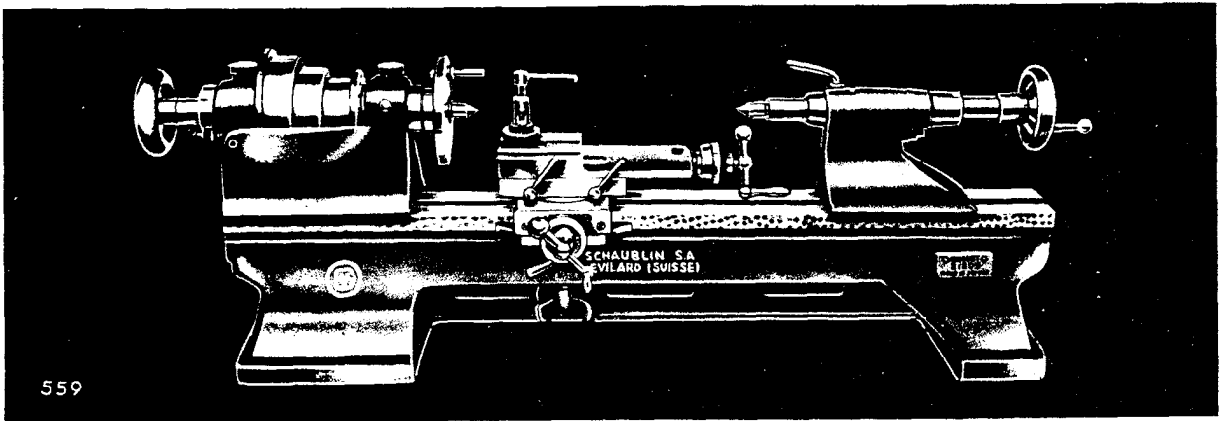

SV 70

Item No.	Standard Equipment — Lathe SV 70
1	Bed with fixing bolts
13	Headstock , bore of spindle 12 mm, with driving plate and male centre
277	Tailstock with male centre
343	Carriage with toolpost and adjustable verniers
506	Hand rest

Lathe SV 65 : same equipment with headstock No. 13, bore of spindle 10 mm.

GENERAL CHARACTERISTICS
TOOLMAKERS' LATHES SV 65-70



Item No.			SV 65	SV 70
	Height of centres	mm	65	70
	Distance between centres	»	210	275
	Swing	»	5 1/8"	5 1/2"
1	Bed			
	Length of bed	mm	500	600
	Height of bed	»	110	120
13	Headstock for type W collets			
	Hole in spindle	mm	10	12
	Bore through collet	»	6,2	8,2
	Width of steps of pulley	»	with grooves	19
	Diameter of steps of pulley	»	48 - 60 - 76	48 - 64 - 80
	Maximum speed :			
	Headstock with plain-bearings	rpm	4500	4500
	Headstock with ball-bearings 13 R. and 191 R.	»		10 000
8	Saddles			
	Height of centres with saddles	mm	90	95
277	Tailstock			
	Stroke of spindle	mm	45	45
343	Carriage with toolpost			
	Stroke of slides long	mm	55	55
	transv.	»	55	55
	Dimensions of tools	»	6 x 6	6 x 6
	Maximum dia. over carriage	»	80	90
	Height over carriage	»	11	16
	Weight Net	kg	18.4 (41 lbs.)	25 (55 lbs.)
	Gross ordinary	»	32 (71 lbs.)	40 (88 lbs.)
	overseas	»	45 (99 lbs.)	55 (121 lbs.)
	Space required	mm in.	675 x 260 x 220 27" x 10" x 8"	800 x 260 x 240 32" x 10" x 9"
	Packing Ordinary	cm in.	67 x 33 x 33 27" x 13" x 13"	
	Overseas	cm in.	77 x 43 x 43 31" x 17" x 17"	



TEST CHART FOR TOOLMAKERS' LATHES

Height of centres 65 to 120 mm

Order No.

Machine No.

Headstock No.

Carriage No.

Tailstock No.

Test to be applied	Permissible Error	Actual Error	Fig.	
Bed Bed straight in longitudinal direction (apron side) convex only	+ 0,02 - 0,01 1000 mm		1 a	
Ditto, opposite side	+ 0,01 0 1000 mm		1 b	
Bed level in transverse direction	0,05 1000 mm		1 c	
WORK SPINDLE Centre point for true running	0,01		3 a	
Spindle nose for true running	0,005		3 b	
Work spindle for axial slip	0,01		3 c	
Taper of work spindle for true running, measured at end of 300 mm mandrel.	0,02		1 d	
Work spindle parallel with bed in vertical plane (rising towards free end of mandrel only)	+ 0,01 0 300 mm		1 d	
Ditto, in horizontal plane (free end of mandrel inclined towards direction of tool pressure only)	0 - 0,01 300 mm		1 e	
CARRIAGE Upper slide parallel with work spindle in vertical plane	0,02 300 mm		4	
TAILSTOCK Sleeve parallel with bed in vertical plane (rising towards free end only)	+ 0,01 0 300 mm		5 a	
Ditto, horizontal plane (free end inclined towards direction of tool pressure only)	0 - 0,01 300 mm		5 b	
Axis of centres parallel with bed in vertical plane, measured on mandrel between centres (rising towards tailstock only)	+ 0,01 0 300 mm		6	

Bévilard, the

Inspector :

Foreman :

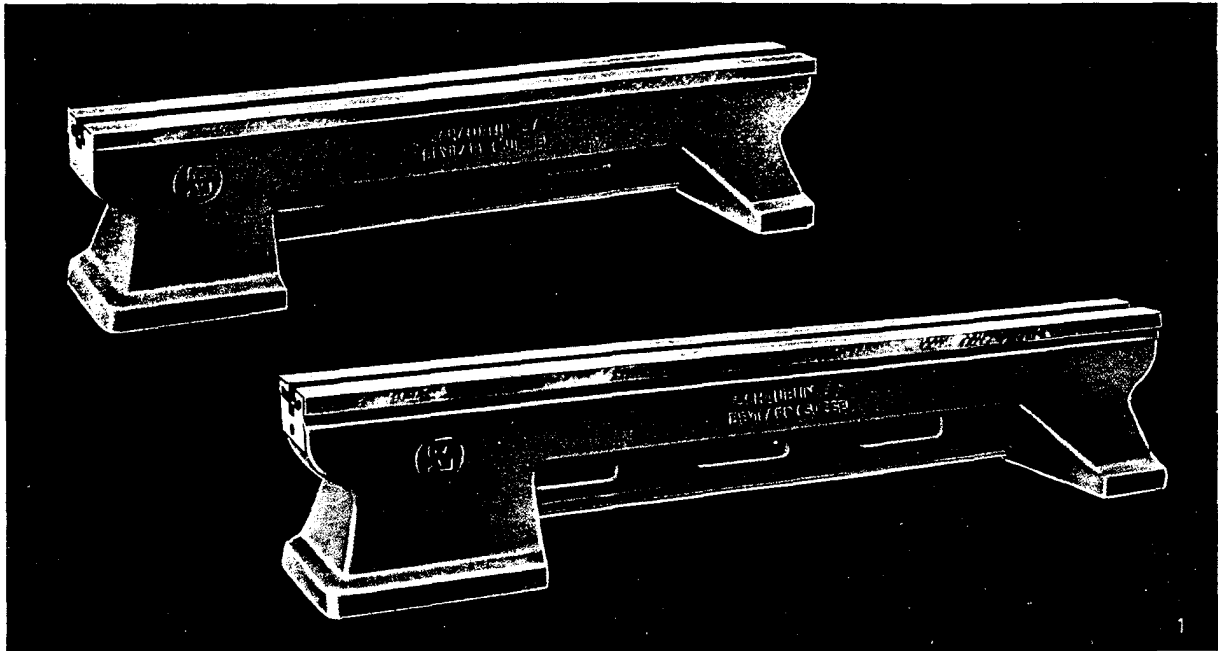

RAISING BLOCKS

- 1 SV 65 – 9,9 kg length 500 mm height 110 mm
- 1 SV 70 – 13,5 kg length 600 mm height 120 mm

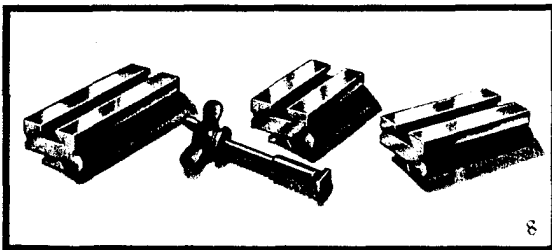

- 8 Set of 3 raising blocks, height 25 mm
- SV 65 2,5 kg SV 70 3 kg

HEADSTOCKS

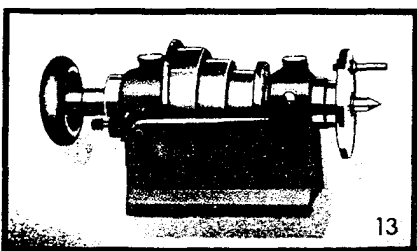
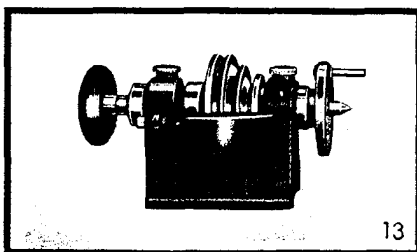

Headstock type	Item No.	Spindle			Pulley		Spindle mounting	Weight kg
		Hole in spindle mm	Collet type	Bore through collet mm	Width mm	Diam. of steps mm		
SV 65	13	10	W 10	6,2	Grooves for belt ø 6 mm	48 60 76	Plain bearings: spindle with tapers of 3 and 45° at front, cylindrical at rear	3,2
	191	Headstock SV 65 No. 13 with lever-operated quick-chucking mechanism No. 174						4,3
SV 70	13	12	W 12	8,2	19	48 64 80	Plain bearings: spindle with tapers of 3 and 45° at front, cylindrical at rear	4,5
	191	Headstock SV 70 No. 13 with lever-operated quick-chucking mechanism No. 174						5,2
SV 70	13 R	12	W 12	8,2	19	48 64 80	Double-row cylindrical roller-bearing at front, 2 ball-bearings at rear	5,6
	191 R	Headstock No. 13 R with lever-operated quick-chucking mechanism No. 174						6,3



ACCESSORIES FOR HEADSTOCKS

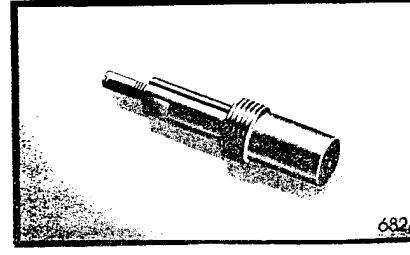
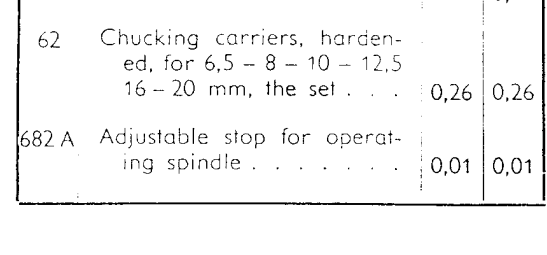
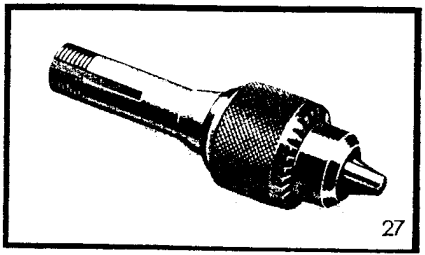
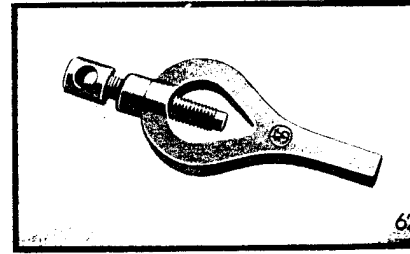
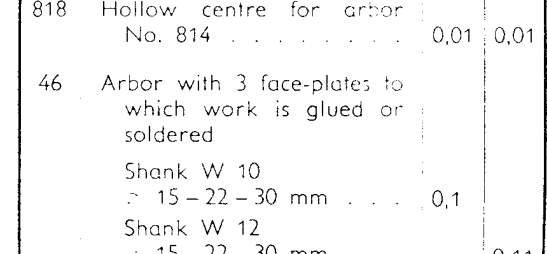
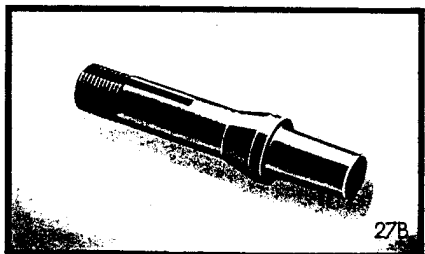
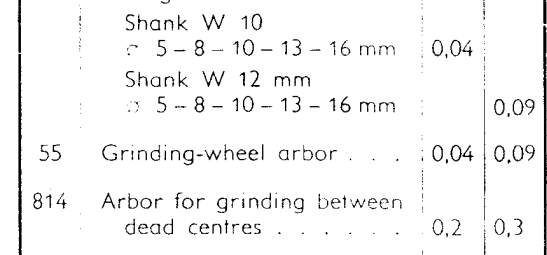
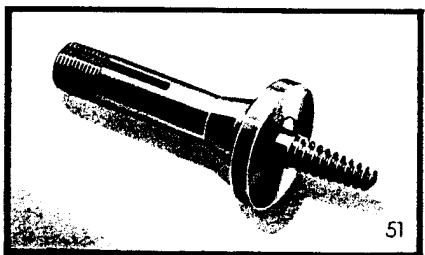
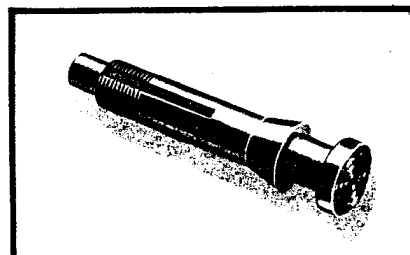
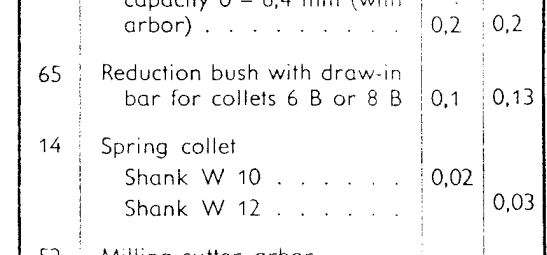
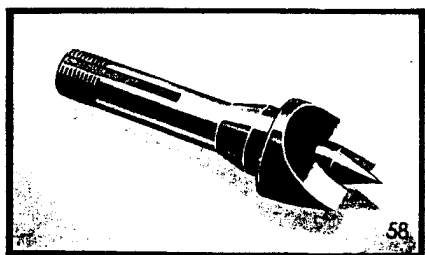
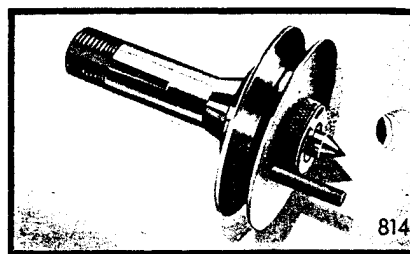
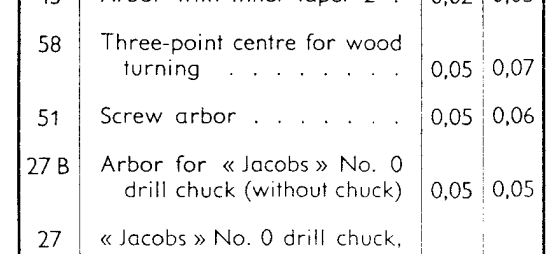
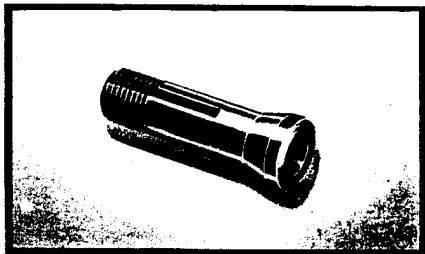
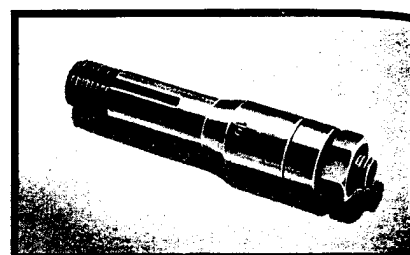
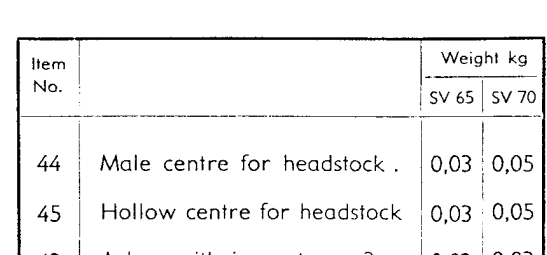
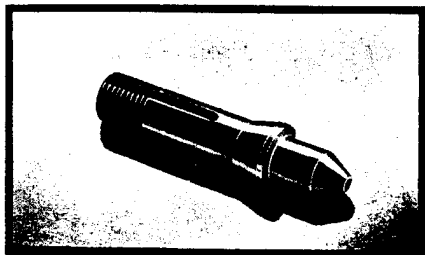
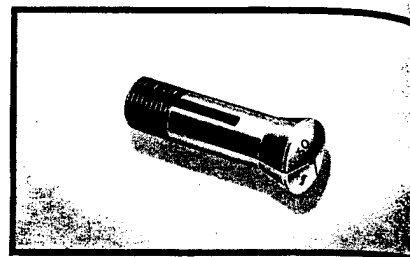
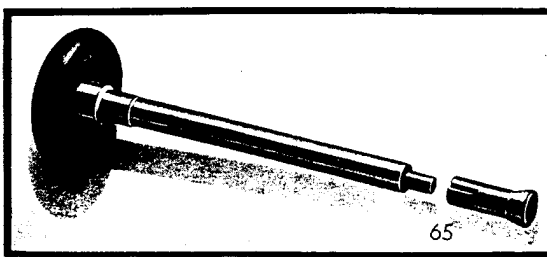
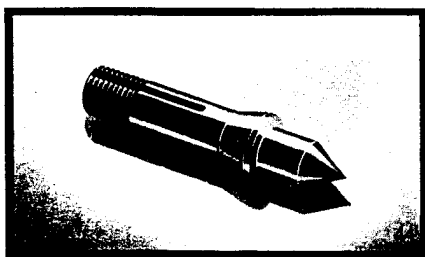

Item No.		Weight kg	
		SV 65	SV 70
44	Male centre for headstock .	0,03	0,05
45	Hollow centre for headstock	0,03	0,05
43	Arbor with inner taper 2° .	0,02	0,03
58	Three-point centre for wood turning	0,05	0,07
51	Screw arbor	0,05	0,06
27 B	Arbor for « Jacobs » No. 0 drill chuck (without chuck)	0,05	0,05
27	« Jacobs » No. 0 drill chuck, capacity 0 – 6,4 mm (with arbor)	0,2	0,2
65	Reduction bush with draw-in bar for collets 6 B or 8 B	0,1	0,13
14	Spring collet Shank W 10	0,02	0,03
	Shank W 12		
52	Milling-cutter arbor Shank W 10 ∅ 5 – 8 – 10 – 13 – 16 mm	0,04	0,09
	Shank W 12 mm ∅ 5 – 8 – 10 – 13 – 16 mm		
55	Grinding-wheel arbor	0,04	0,09
814	Arbor for grinding between dead centres	0,2	0,3
818	Hollow centre for arbor No. 814	0,01	0,01
46	Arbor with 3 face-plates to which work is glued or soldered Shank W 10 ∅ 15 – 22 – 30 mm	0,1	0,11
	Shank W 12 ∅ 15 – 22 – 30 mm		
62	Chucking carriers, hardened, for 6,5 – 8 – 10 – 12,5 – 16 – 20 mm, the set	0,26	0,26
682 A	Adjustable stop for operating spindle	0,01	0,01

ACCESSORIES FOR HEADSTOCKS



Arbors

- 79 Shank W 10 – Lathe SV 65
Blank head \varnothing : 14 – 20 – 25 – 30 mm
Length of head : 40 mm
- 79 Shank W 12 – Lathe SV 70
Blank head \varnothing : 16 – 20 – 25 – 30 – 40 mm
Length of head : 40 mm

Expanding arbors (without closing rod)

- 79 A Shank W 10 – Finished head
Finished head \varnothing : D = 6 – 8, 9 – 11, 12 – 14 mm
Length of head : L = 10 15 20 mm
- 79 A Shank W 12 – Finished head
Finished head \varnothing : D = 6 – 8, 9 – 11, 12 – 14, 15 – 17 mm
Length of head : L = 10 15 20 25 mm

- 635 Nut with closing rod for No. 79 A
- 116 Stop nut for spindle nose
- 160 **Expanding arbors with interchangeable bushes**
for powerful and concentric clamping over entire length Shank
W 12 – Clamping \varnothing : 17 to 30 mm, clamping length : 30 mm

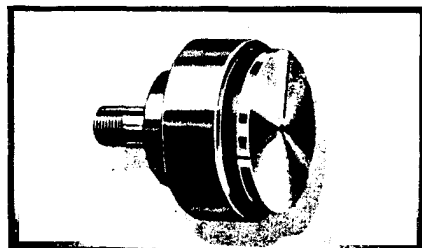
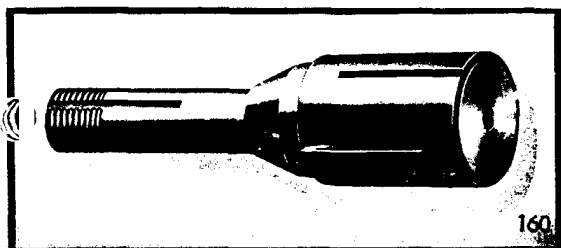
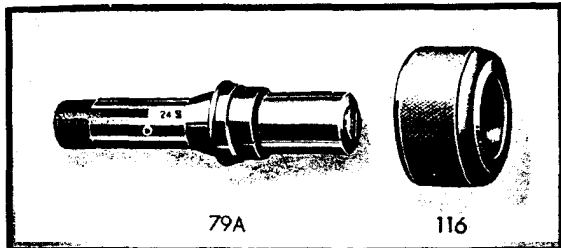
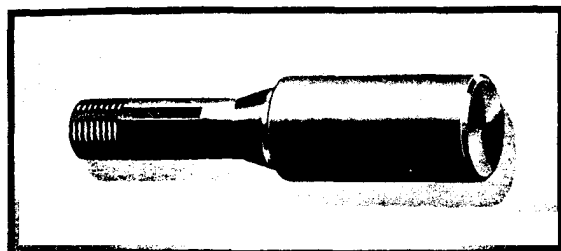

72/73

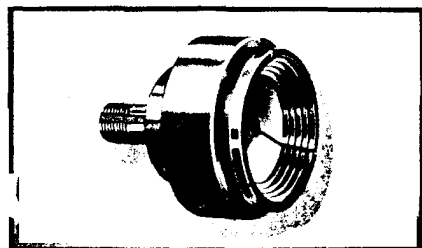

72A/73

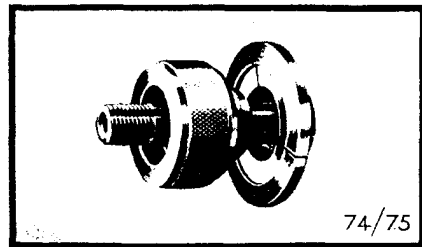

74A/75

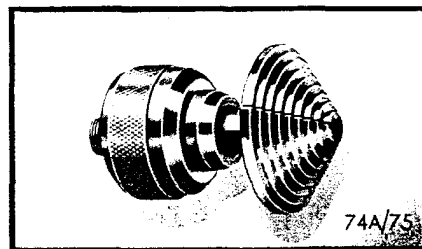

74A/75

Blank

STEP-COLLETS

Size	I	II	III	IV	V
No. of collet	69	70	72	77	80
Weight	kg 0,2	kg 0,25	kg 0,35	kg 0,5	kg 0,75
Capacity SV 65	24	40	56	72	—
Capacity SV 70	27	43	59	75	91
No. of closer	68	71	73	78	81
Weight	kg 0,07	kg 0,13	kg 0,22	kg 0,45	kg 0,5

With turned steps

Item No.	Size	Type	Weight kg	No. of steps	\varnothing of steps mm	Remarks
69 A	I	65	0,1	4	9 – 24	The interval between the steps is 4 mm.
		70	0,15		12 – 27	
70 A	II	65	0,15	4	25 – 40	In order to obtain all diameters in stages of one millimetre, 4 collets of each size with 4 steps per collet are required for each type.
		70	0,2		28 – 43	
72 A	III	65	0,25	4	41 – 56	
		70	0,3		44 – 59	
77 A	IV	65	0,3	4	57 – 72	
		70	0,38		60 – 75	
80 A	V	—	—	4	—	
		70	0,45		76 – 91	

EXTERNAL STEP CHUCKS

- 74 Blank kg 0,15
- 74 A With turned steps kg 0,12
- 75 Expanding ring kg 0,1

To obtain all steps in stages of one millimetre the following numbers of chucks are necessary :

SV 65 – Shank W 10, \varnothing 8-43 mm : 4 chucks SV 70 – Shank W 12, \varnothing 10-49 mm : 5 chucks



DIVIDING ATTACHMENTS

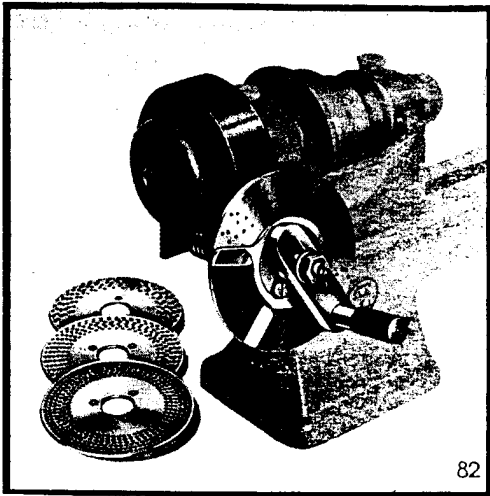

- 82 **Dividing attachment with 4 discs**, each with 6 circles of divisions giving nearly all numbers between 2 and 360. Ratio between gear and wormwheel 1 : 60.
2,2 kg.

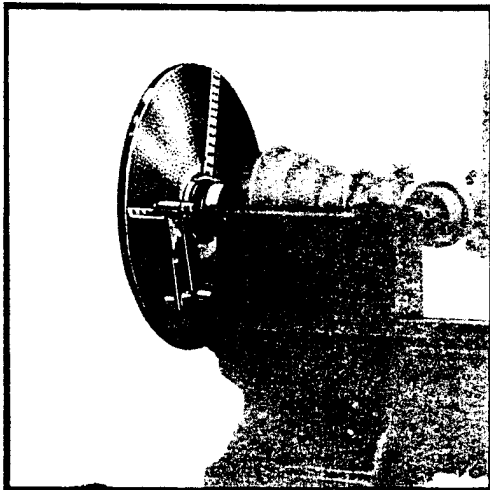

- 76 **Brass dividing plate** with 24 divisions marked on the indexes :
74 – 76 – 82 – 88 – 104 – 108 – 116 – 124 – 128
132 – 136 – 144 – 156 – 168 – 170 – 172 – 184
188 – 196 – 220 – 240 – 280 – 300 – 360.
1,5 kg.

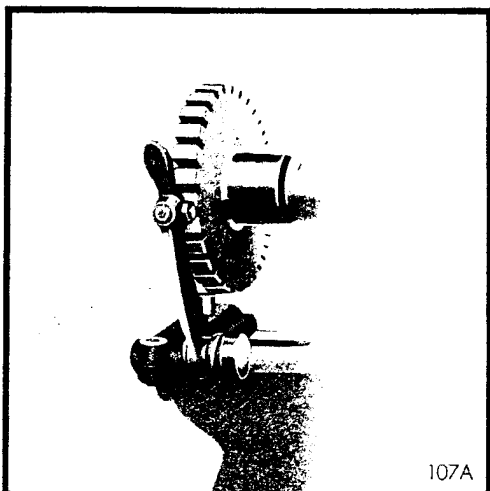

- Dividing plate with pawl** for use with head-stock or quill.
- 110 Dividing plate, 60 teeth, bore 15 mm for SV 65
0,35 kg. bore 19 mm for SV 70
- 107 A Pawl with base for mounting on bed
0,28 kg.

CARRIAGES AND ACCESSORIES FOR CARRIAGES

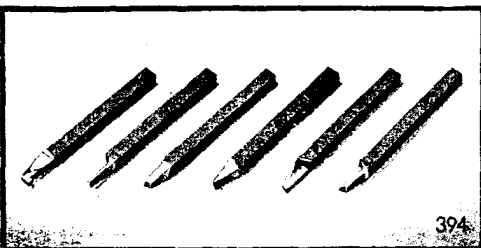
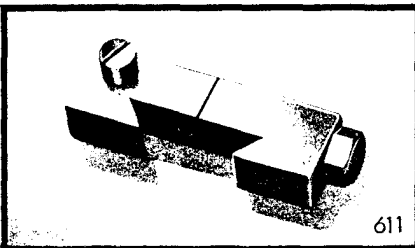
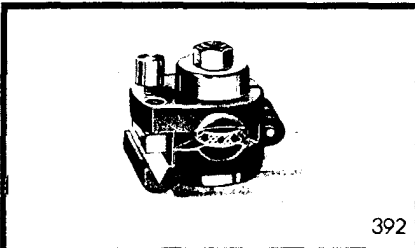
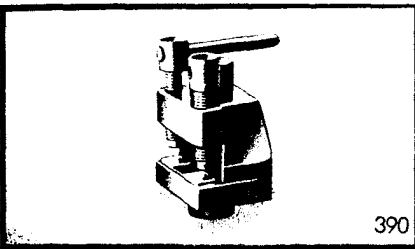
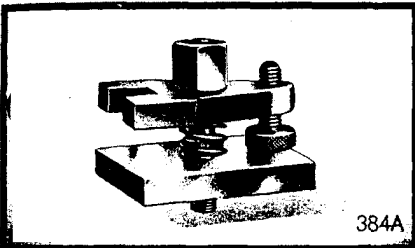
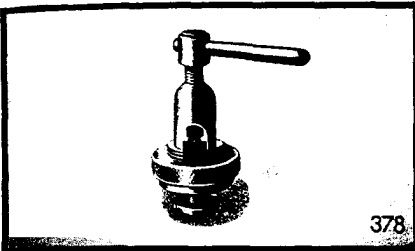
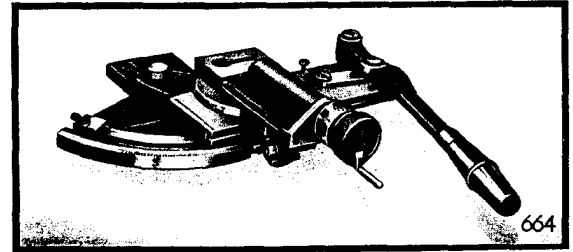
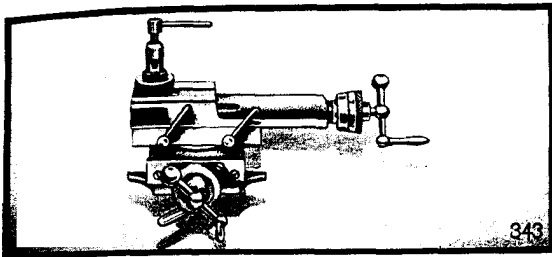

Item No.		Weight kg	
		SV 65	SV 70
343	Carriage with micrometer screws 1. Fully protected slides 2. Protected micrometer screws 3. Adjustable verniers reading to 1/100 mm 4. Cross slide swivels 90° either side Long. stroke 55 mm Trans. stroke 55 mm	2,8	2,8
	Accessories		
378	Tool-post for tools 6 x 6 mm	0,07	
384 A	Tool-clamp	0,17	
390	Tool-post with 2 screws	0,2	
	SV 65 tool 6 x 6 mm		
	SV 70 tool 7 x 7 mm		
392	Adjustable tool-post for triangular tool 8 mm		
611	Stop for slide	0,4	
612 G	Screw with adjustable vernier for longitudinal slide	0,1	
612 H	Screw with adjustable vernier for cross slide	0,19	
394	Set of 6 tools 6 x 6 mm	0,16	
394 A	Set of round tools \varnothing 5 mm	0,15	
397	Tool holder for round tools	0,07	
		0,02	
664	Carriage for cylindrical and taper grinding, external and internal, and planing Long stroke 50 mm Transv. stroke 40 mm	6	6
	Accessories		
441	Grinding attachment Spindle for collet B 6 mm Pulley with grooves \varnothing 36 mm Speed : 5400 rpm	0,8	
441 R	Grinding attachment No. 441 with spindle mounted on ball-bearings. Maximum spindle speed 30 000 rpm.	0,95	
457	Wheel arbor for external grinding, Shank diam. 6 mm	0,02	
455	Wheel arbor for internal grinding, Shank diam. 6 mm Min. diam. of hole 3,5-4,5 mm Length of grinding 18 - 24 mm	0,01	
441/14	Collet for No. 441, shank diam. 6 mm.	0,02	
444	Internal grinding attachment Spindle with taper. Pulley with groove diam. 25 mm Stroke 33 mm. Speed 7800 rpm	0,6	

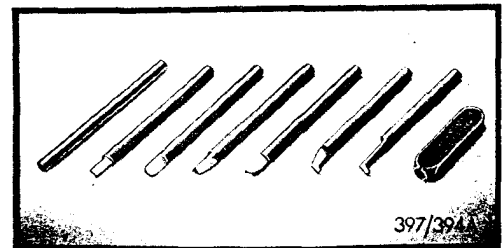
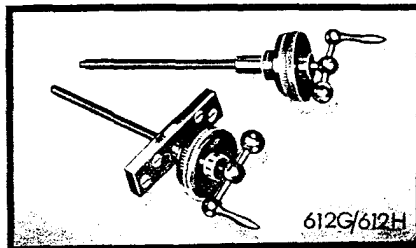
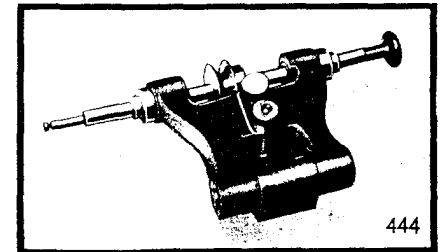
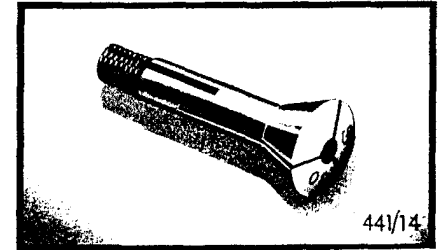
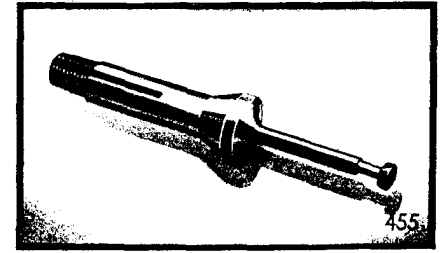
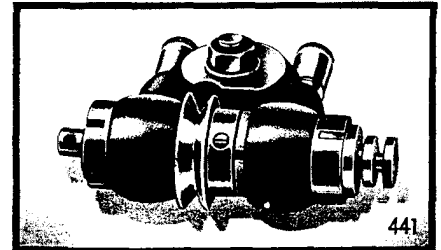



ATTACHMENTS FOR CARRIAGES

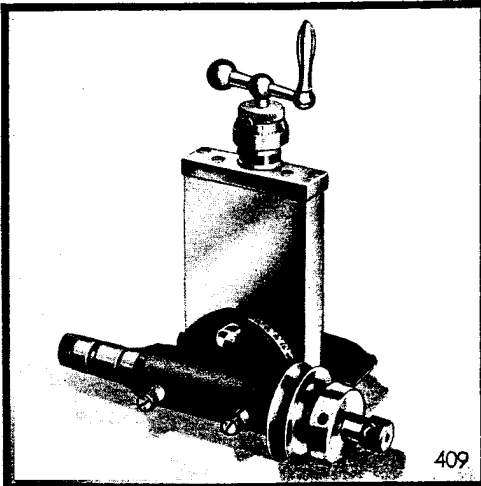

The milling attachment upright No. 409 A can accommodate the following accessories :

- Cutter headstock
- Work headstock
- Parallel vice
- Swivelling angle-plate

specification as per table below :

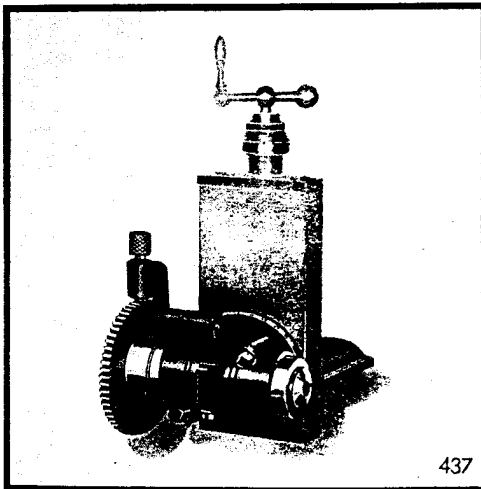

Item No.		Weight kg
409	Milling attachment with inclinable headstock Vertical stroke 60 mm Inclination from 0 to 360° Spindle for collet type B 8 Pulley with 2 grooves diam. 42-32 mm for belt ∅ 5 mm Speeds : 1300 and 3000 rpm	2
435	Milling-cutter arbor , shank type B 8 Diameter 5 - 8 - 10 - 13 - 16 mm	0,03
437 110 108	Work headstock , spindle for collet type W 20 Division plate 60 teeth Spring pawl	1,5
409/27	Parallel vice , width of jaws 50 mm Max. opening 35 mm	1,7
412	Swivelling angle plate with T-slots : 2 longitudinal slots 3 transversal slots Working surface : 90 × 60 mm	0,7

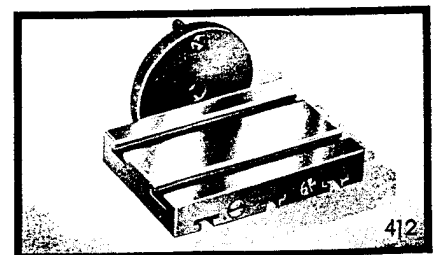
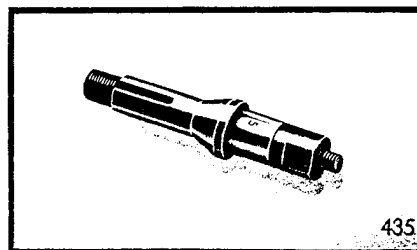
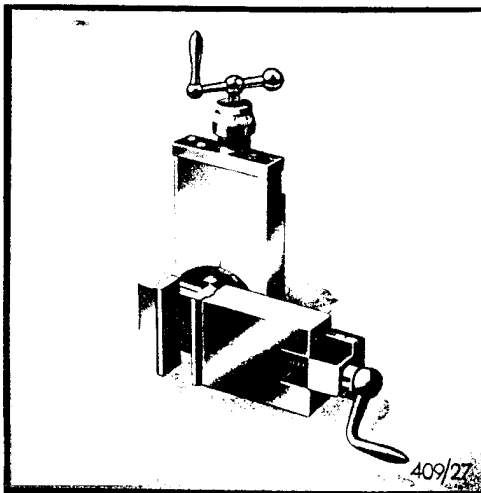

TAILSTOCKS

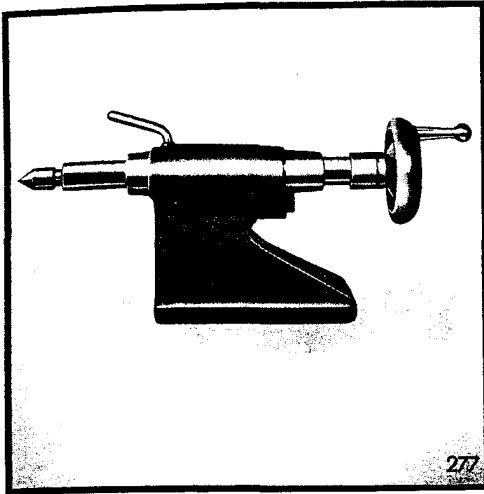

Item No.		Weight kg	
		SV 65	SV 70
277	Tailstock with screw and handwheel, spindle with inner taper 2°, stroke of spindle 45 mm	2	2,3
302	Lever-operated tailstock for repetition work, spindle for collet :		
	SV 65 : type W 10	2	
	SV 70 : type W 12		2,7

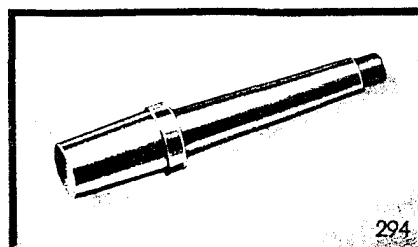
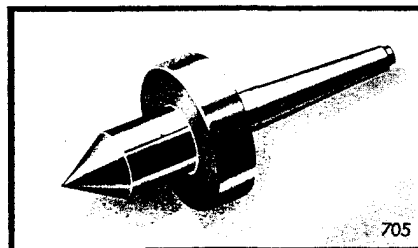
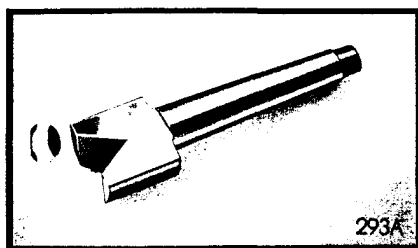
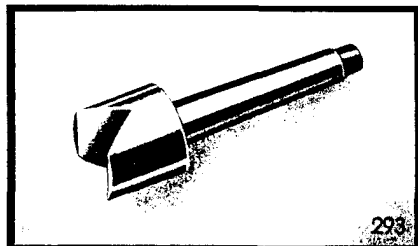
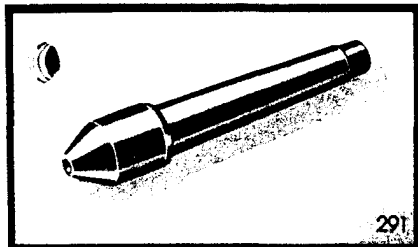
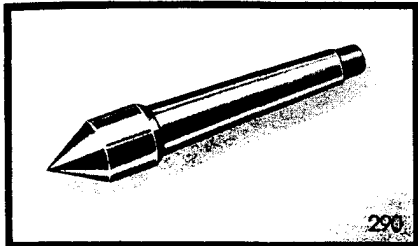
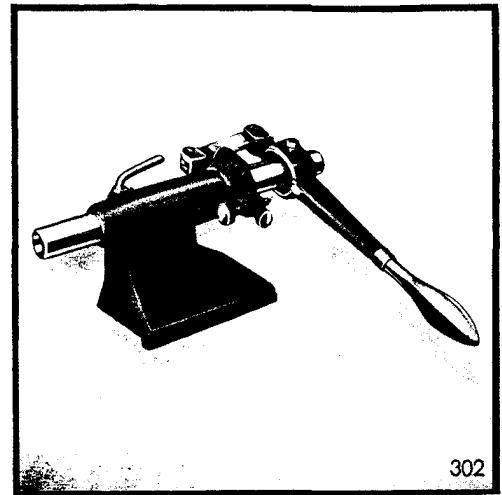

Accessories for Tailstocks

Item No.	Taper 2°	Weight kg	
		SV 65	SV 70
290	Male centre	0,02	0,03
290 A	Half male-centre	0,02	0,03
291	Hollow centre	0,02	0,03
291 A	Half hollow-centre	0,02	0,03
293	Drilling V	0,03	0,04
293 A	Half drilling-V	0,03	0,04
296	Revolving V	0,05	0,06
705	Revolving centre	0,15	0,15
294	Shank for drill chuck	0,05	0,05
292	Drill plate, diam. 30 mm	0,04	
	Drill plate, diam. 35 mm		0,06
292 A	Drill plate, diam. 50 mm	0,12	0,13
292 B	Drill plate, diam. 70 mm	0,14	0,15
292 C	Drill arbor	0,03	0,05
27 A	" Jacobs " type, drill chuck, cap. 6,4 mm mounted on arbor no. 294	0,2	0,2

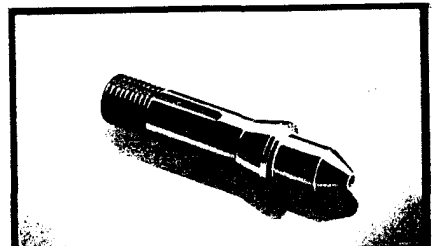
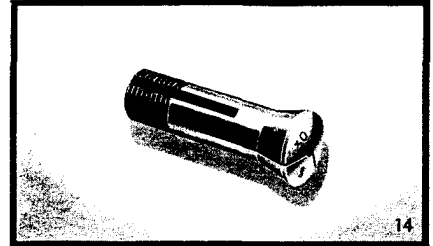

Accessories for Lever-operated Tailstock

Item No.	Shank W 10 or W 12	Weight kg	
		SV 65	SV 70
14	Collet type W 10	0,02	
	type W 12		0,03
44	Male centre	0,03	0,05
45	Hollow centre	0,03	0,05
27 B	Arbor for drill chuck (without chuck)	0,05	0,05
27	" Jacobs " type drill chuck, with arbor, cap. 0 - 6,4 mm	0,2	0,2

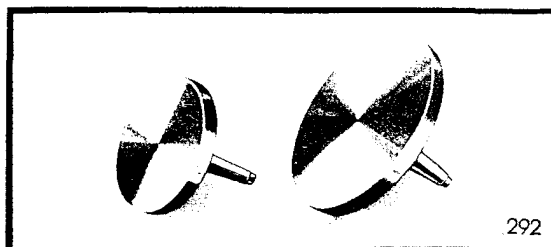
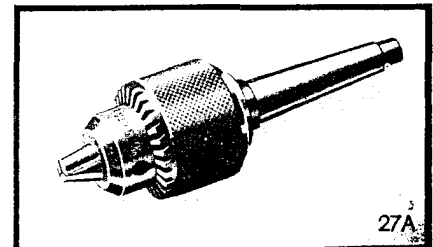
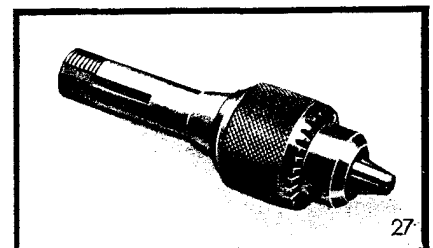
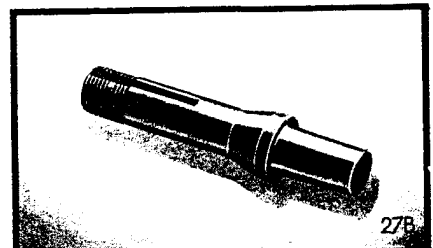



ATTACHMENT FOR SCREWCUTTING BY CARRIAGE AND UNIVERSAL JOINTS

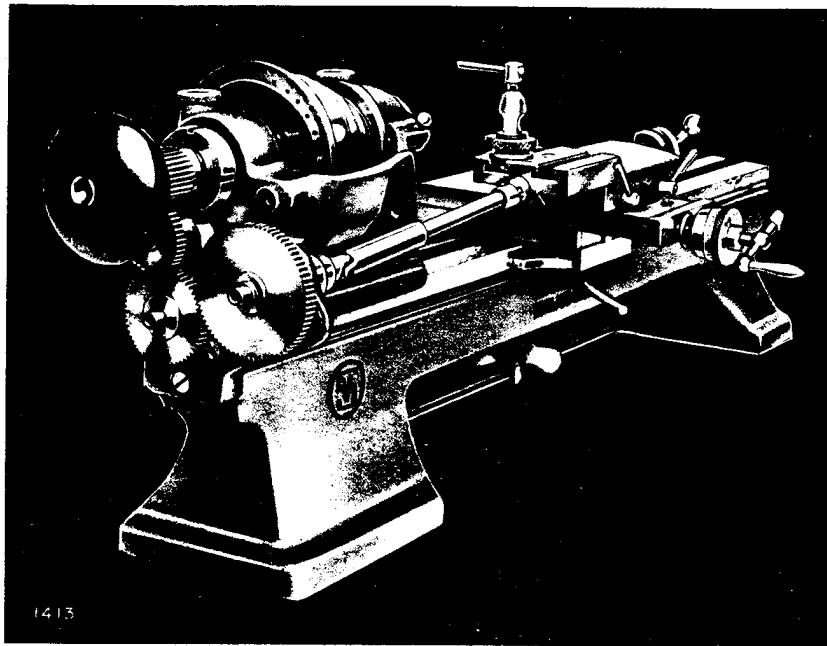

111
kg 1,5

Of simple design, this attachment allows the cutting of threads up to 1,25 mm pitch on a length of 50 mm by means of the carriage No. 343.

- a) with metric screws and set of 9 gears for cutting the following threads :
0,25 - 0,30 - 0,35 - 0,40 - 0,45 - 0,50 - 0,55 - 0,60 - 0,70 - 0,75 - 0,80 - 0,85 - 0,90 - 1 - 1,25 mm.
- b) with inch screws and set of 15 gears for cutting the following threads :
80 - 72 - 68 - 64 - 60 - 56 - 52 - 50 - 48 - 46 - 44 - 42 - 40 - 38 - 36 - 34 - 32 - 30 - 28 - 26 - 25 - 24 -
22 - 20 - 18 per inch.

Gears required for cutting other threads can generally be supplied from stock.

SCREWCUTTING TOOLS AND TOOLHOLDERS

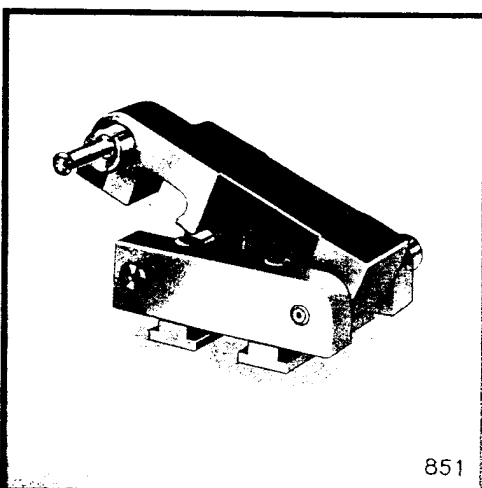
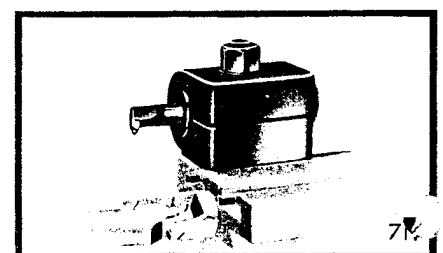
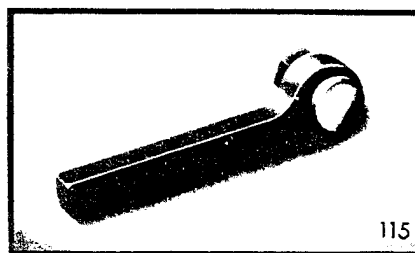
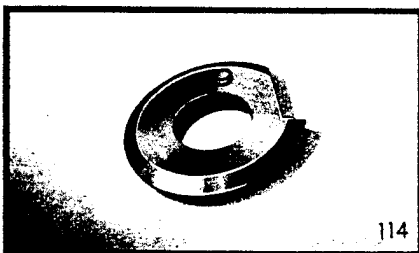

Item No.	For use with attachment No. 111	Weight kg
114	Circular screw-cutting tool, 55 or 60°, diam. 24 mm	0,005
115	Toolpost for circular screw-cutting-tool No. 114	0,03
711	Adjustable toolholder for internal screw-cutting Diam. of tool 8 mm Eccentricity of tool 15 mm	0,22
851	Hinged toolholder for internal threads Diam. of internal-threading tool 8 mm	0,65

LATHE FOR CENTRING WITH MICROSCOPE

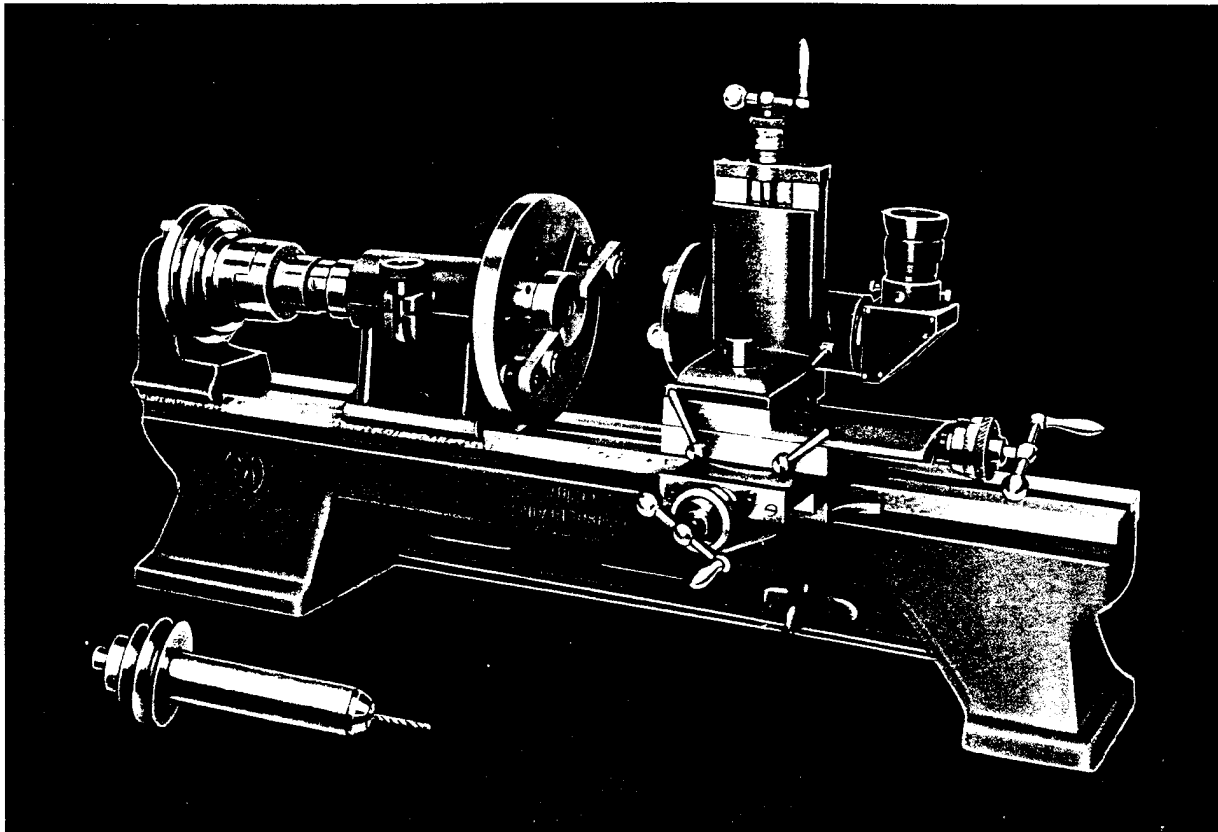

Item No.	Standard equipment	Weight kg	
		SV 65	SV 70
1	Bed on 2 legs	9,9	13,5
265	Hinged quill-holder, bore 35 mm	1,8	2,3
105 A ou 105 B	Quill with face plate with tapped holes and 3 slots, with dogs and centring pump	2,5	2,5
251	Headstock with carrier	1,4	1,7
668 A	Square carrier	0,29	0,29
343	Carriage with adjustable verniers	2,8	2,8
409 A	Upright of milling attachment	1,2	1,2
420	Quill-holder, bore 25 mm	1	
702	Quill \varnothing 25 mm for collet type B 8 with pulley with 2 grooves \varnothing 44-55 mm	0,6	0,6
1370	Elbowed microscope magnifying 65 \times, with concentric circles and reticule	0,4	0,4
1371	Disc with 3 bulbs for illuminating the part to be centred (8 Volts)	0,1	0,1



QUILLS AND QUILL-HOLDERS

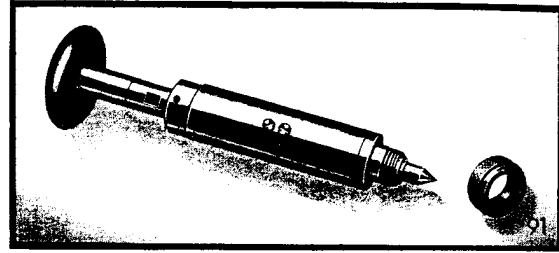
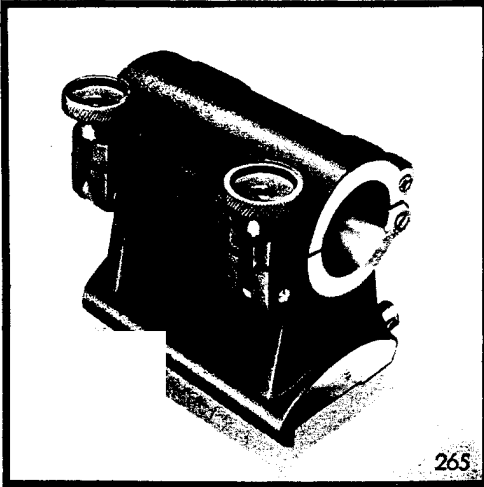

265 Hinged quill-holder,

bore 35 mm

SV 65, length 100 mm 1,8 kg

SV 70, length 100 mm 2,3 kg

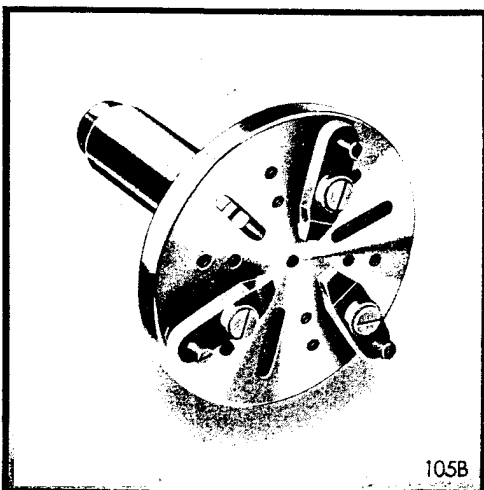

Item No.	Plain quills with spindle for collet and draw-in bar	Weight kg
91 A	Quill Ø 35 mm Spindle nose SV 65 collet type W 10, with male centre and protecting ring .	1,2
91 B	Quill Ø 35 mm Spindle nose SV 70 collet type W 12, with male centre and protecting ring .	1,2
702	Quill Ø 25 mm Spindle nose without thread, collet type B 8	0,65
Quills with face plate with tapped holes and 3 slots with dogs and centring pump		
105 A	Quill Ø 35 mm Plate Ø 128 mm, with 3 dogs for slots	2,6
105 B	Quill Ø 35 mm Plate Ø 128 mm, with 3 dogs for tapped holes, for clamping work directly on face plate	2,5

CENTRING ATTACHMENTS

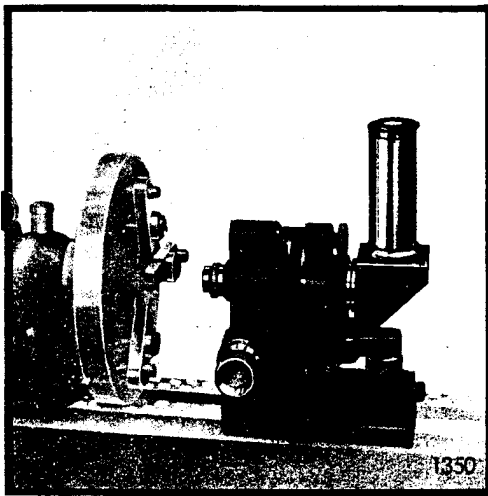
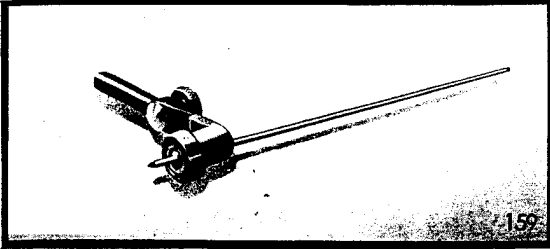
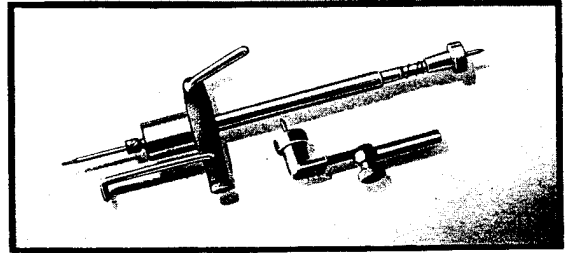
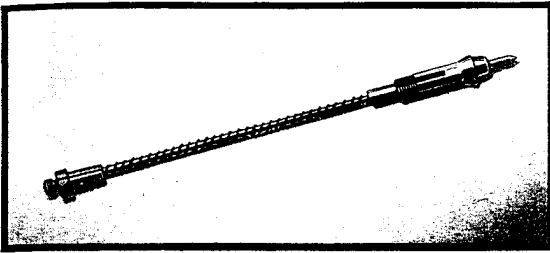

Item No.	Description	Weight kg	
		SV 65	SV 70
95	Centring pump for quills with face plate or for headstock	0,06	0,1
154	Attachment for centring from back and front	0,34	0,37
159	Attachment for centring from front	0,07	0,07
1350	Microscope holder for fitting on bed, adjustable in all directions	1,4	1,4
1370	Elbowed microscope , magnifying 65 ×, with concentric circles and reticule	0,4	0,4
1371	Disc with 3 bulbs , for illuminating the part to be centred (8 Volts)	0,1	0,1

PULLEYS AND CARRIERS

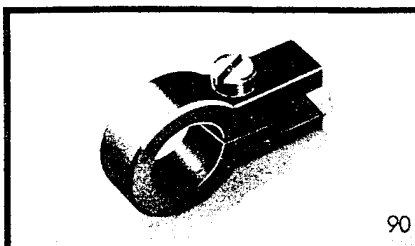
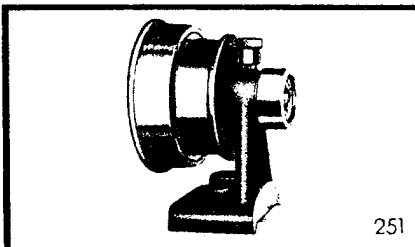
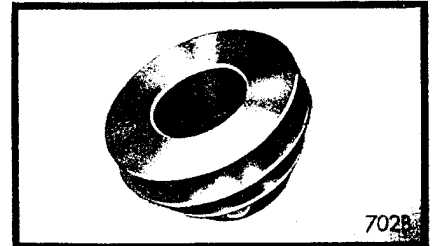
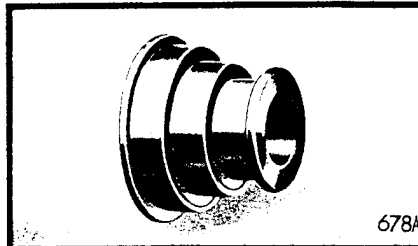

Item No.	Drive pulleys for direct drive	Weight kg	
		SV 65	SV 70
678 A	Pulley with 3 steps for quills No. 91, bore 15 mm and 19 mm SV 70 : \varnothing 48 — 64 — 80 × 18 mm		0,7
678		0,4	
702 B	Pulley with 2 steps for quills No. 702, bore 12 mm, \varnothing 44 — 55 mm	0,22	0,22
	Carriers for indirect drive		
251	Headstock with carrier SV 70, pulley with 2 steps \varnothing 64 — 84 × 18 mm . SV 65, pulley with 3 grooves \varnothing 52 — 68 — 84 mm	1,4	1,7
668	Square carrier for quills No. 91 with special draw-in bar and key	0,36	0,36
668 A	Square carrier for quills with face plate No. 105 A - B	0,29	0,29
90	Fork-carrier	0,1	0,1



VARIOUS ACCESSORIES

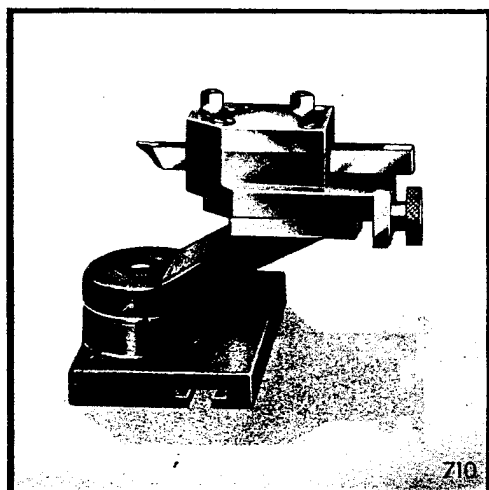
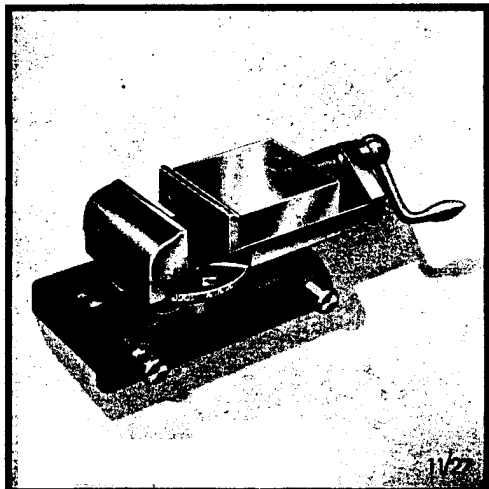
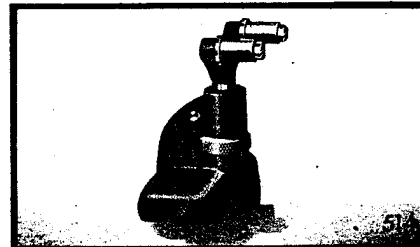
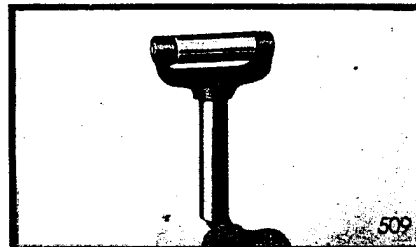
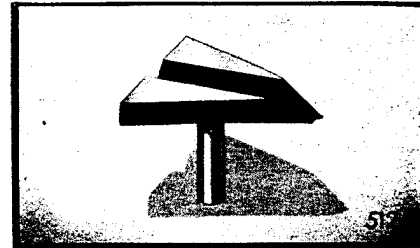
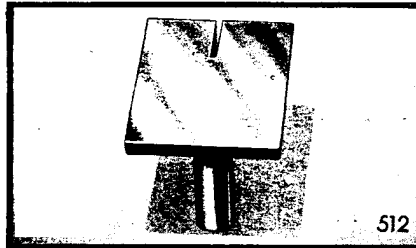
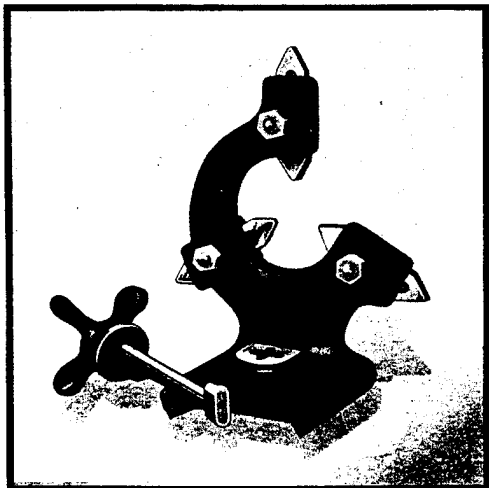
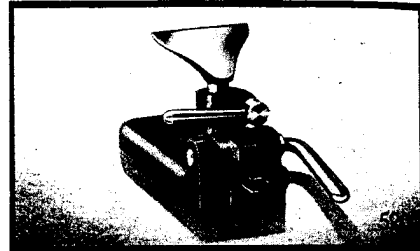
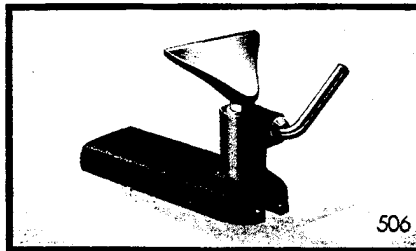
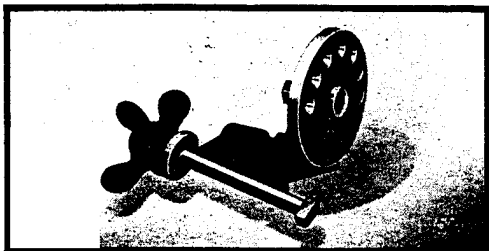

Item No.		Weight kg	
		SV 65	SV 70'
528	Steady rest with holes Diam. 1,5 - 3 - 4,5 - 6 - 7,5 - 9 - 10 mm	0,5	0,7
524	Steady rest with 3 guided cast-iron jaws. Maximum cap. 35 mm . . .	0,8	0,9
506	Hand rest	0,3	0,3
520	Tilting hand-rest	0,4	0,4
512	Rectangular sawing table	0,1	0,1
512 A	Triangular sawing table	0,1	0,1
509	Single filing-roller rest	0,05	0,05
514	Double filing-roller rest	0,25	0,25
11/27	Vice, width of jaws 50 mm opening 35 mm	1,55	1,55
710	Spherical-turning attachment Max. radius 55 mm Stroke of slide 30 mm	1,7	1,7



INDIVIDUAL-DRIVE

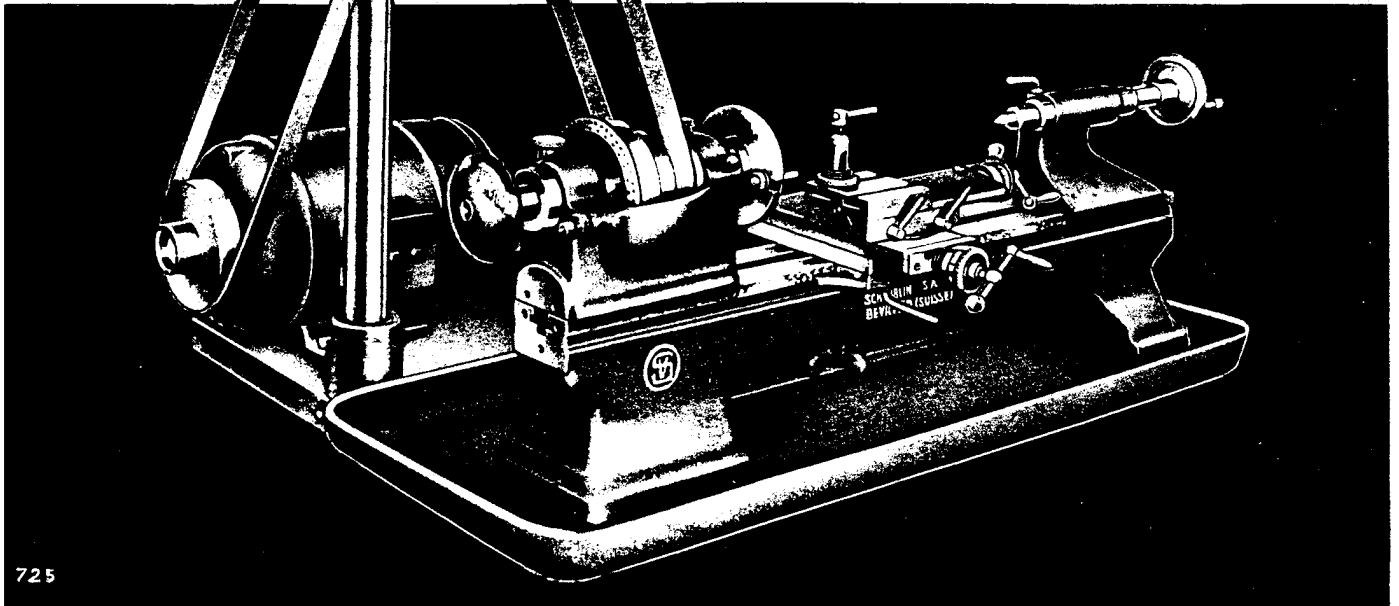

725

<p>Individual drive, comprising :</p>	<p>Weight - Space required Packing</p>
<p>Cast-iron tray Base plate, for mounting on bench Column dia. 30 mm, height 760 mm Countershaft with pulleys and swivel bracket with lever 3-phase-motor : 1/3 hp - 1500 rpm with 2-step-pulley 3-pole switch for mounting under bench</p>	<p>Weight net kg 41 (90 lbs.) gross } ordinary » 66 (145 lbs.) } overseas » 135 (298 lbs.)</p>
<p>Speeds at headstock</p>	<p>Space required mm 760 × 450 × 350 " angl. 30" × 20" × 14"</p>
<p>Lathe SV 70 : 270 — 450 — 730 — 1120 — 1860 — 3080 rpm</p>	<p>Packing ordinary : cm 82 × 50 × 40 " angl. 33" × 20" × 16"</p>
<p>Lathe SV 65 : 250 — 460 — 700 — 1020 — 1960 — 3500 rpm</p>	<p>overseas : cm 93 × 60 × 50 " angl. 37" × 24" × 20"</p>

Three notes in tune...

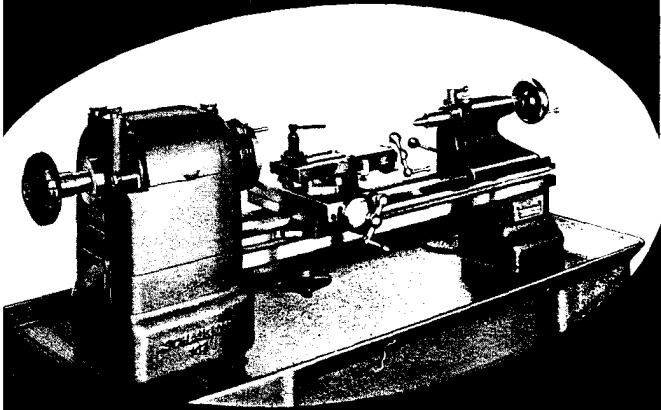

TOOLMAKER'S LATHE

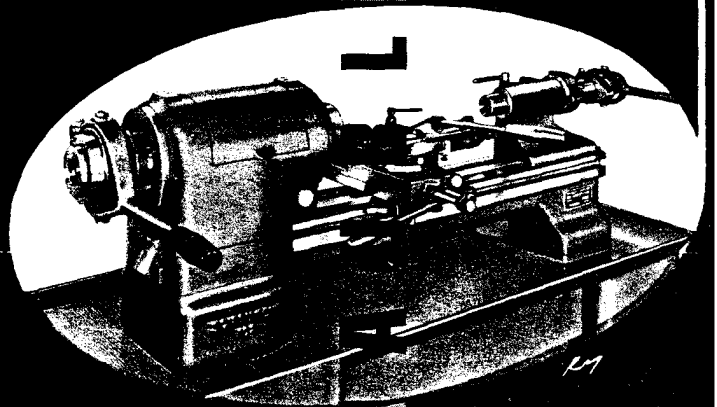

SECOND-OPERATION LATHE

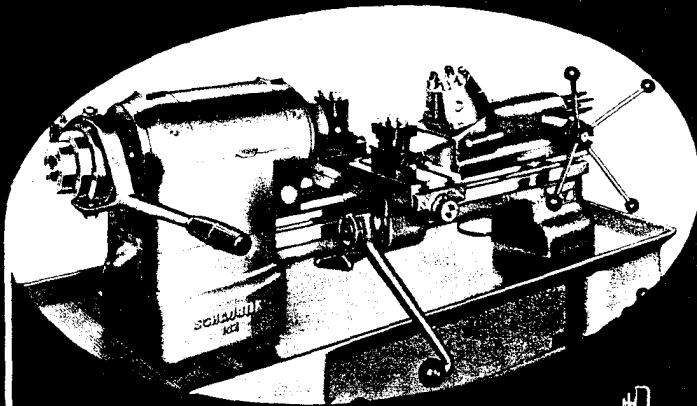

TURRET LATHE

S
C
H
A
U
B
L
I
N

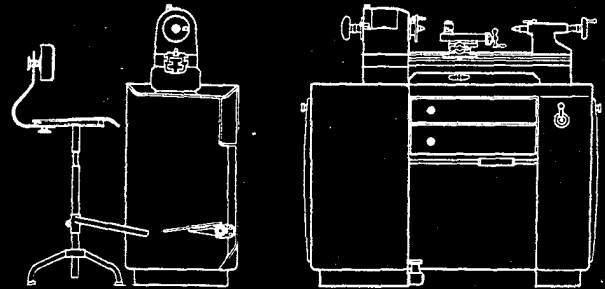

SCHAUBLIN

MACHINE-TOOL MANUFACTURERS SCHAUUBLIN LTD. BÉVILARD-SWITZERLAND

3 high precision

machines

universal milling machine

Schaublin 13

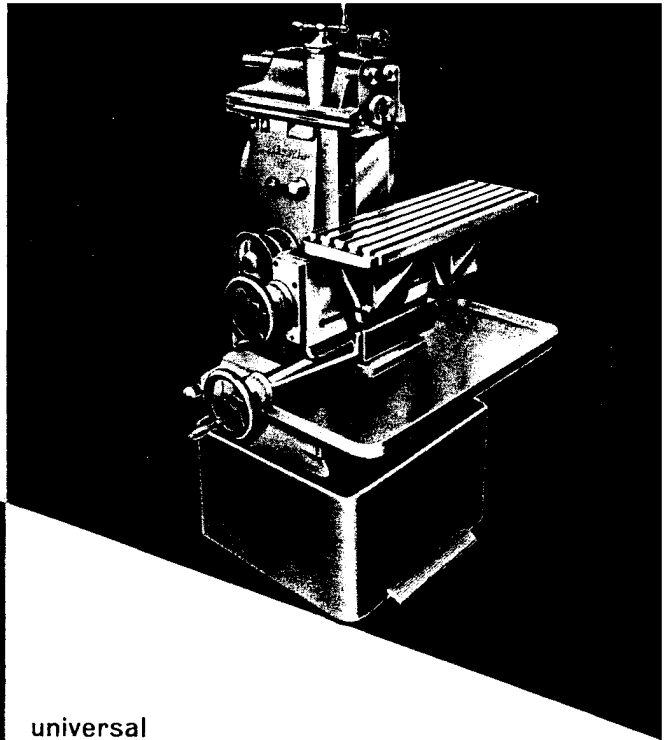

universal

milling machine

Schaublin 53

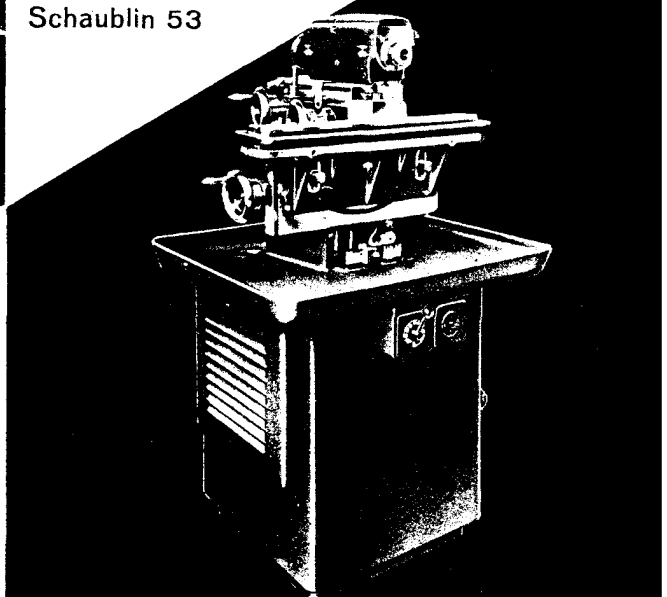

multi-purpose

milling machine

Schaublin 12

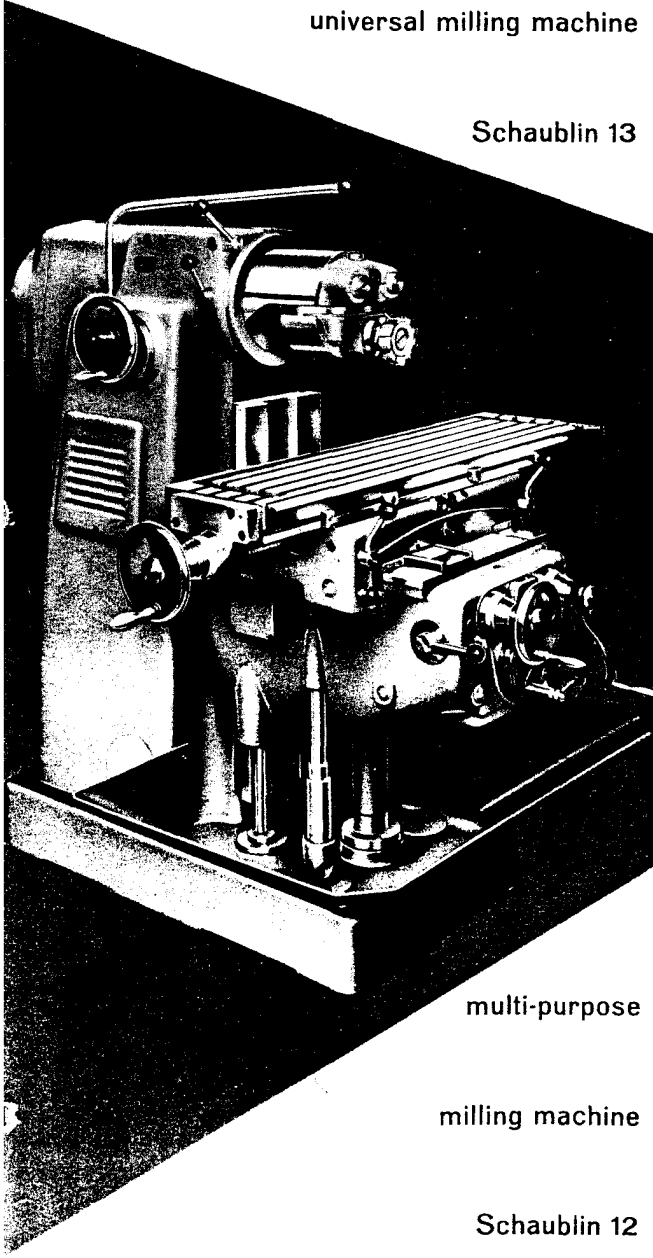

SCHAUBLIN SA

Machine-Tool Manufacturers

Bévilard / Switzerland

Tel. (032) 5 28 52

Fabrique

de machines

SCHAUBLIN SA

Delémont

Tél. (066) 210 81

Type W

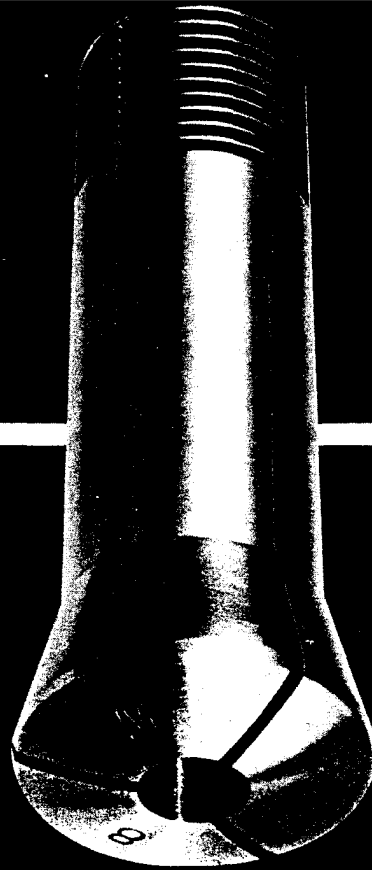

Fabrique

de machines

SCHAUBLIN SA

Delémont

Tél. (066) 210 81

Type A

